

TSTE17 System Design, CDIO

- Lecture 2
 - System Design
 - Tools
 - Intro Digital Communication

Outline

- System Design
- Introduction to the design flow
- Basic approach
- What aspects are important
- What tools do we use
- Channel model

Course news

- LIPS project model described in Lecture 5
 - Thursday 10/9 10.15-12.00

Design Flow

- System modeling incl. environment simulation
 - SDL (System Description Language)
 - C/C++
 - Java
- Algorithm (DSP) modeling
 - Matlab
 - Simulink
 - C/C++

Design Flow, cont.

- Software Implementation
 - SDL
 - C/C++
 - Java
 - Compile/debug environment
- Hardware Implementation
 - HDL + synthesis
 - C/C++ + synthesis

System Partitioning

- Map function blocks to physical units
 - Dedicated HW blocks
 - CPU SW
 - Combinations HW/SW
 - > Performance analysis and modeling important
 - > System simulation!
- Define interfaces between blocks
 - Bit widths
 - Latency
 - Waveforms

The Modelling Hierarchy

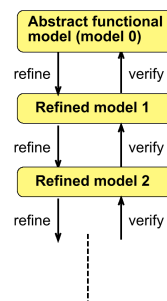

Example – Design of an I/O interface

- Initial model 0

```
data = recieve(inport);
transmit(outport,value);
```

 - > No timing or implementation information
 - > Fast => extensive system simulations possible
- Model 1

```
while status != OK { (data,status) = receive(inport) ; wait 1 clock cycle }
while status != OK { status = transmit(outport,value); wait 1 clock cycle }
```

 - > Some timing information
 - > No implementation information

Example cont.

- Model N
 - Detailed clock accurate timing information
 - Too slow to be used in extensive system simulations

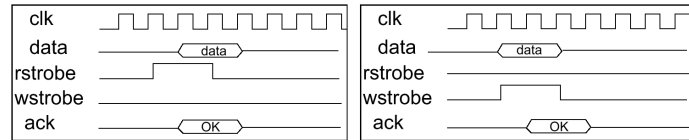

The Design Task

- Conceptual idea => real hardware
 - 50 MSamples/s input
 - Transmit over radio
 - Similar to 802.11a, DRM, or 802.16 (WIMAX)
 - Receive and decode

(A radio channel simulator may be used)

Example cont. - Model N+1

- Gate level description with timing from layout

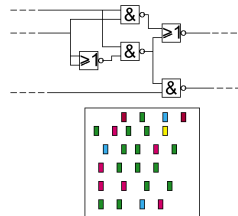

- Slow but accurate
- Only simple functional verification/simulation possible

Roles

- Customer
 - Decide on meetings
 - Need to iterate requirement specifications
 - Kent Palmkvist (kent.palmkvist@liu.se)
- Supervisor
 - Kent Palmkvist (kent.palmkvist@liu.se)
- Meetings arranged by signing up on lists outside office one day ahead or more

Group Roles

- Defined in the LIPS project model
 - Project manager
 - Documentation
 - Design
 - Testing
 -
- All members of the groups should have a role

Design flow cont.

- First model starts with high-level blocks (behavioral)
 - Check functionality
 - Create a good testbench
 - Find limits of noise on channel (#bits in A/D & D/A)
- Second model adds details on algorithms (functional)
 - Select algorithms
 - Check wordlength (between blocks)
 - Find limits on wordlength (try to reduce)

Requirement specification

- Multiple versions
 - Each model level should produce a new requirement specification
 - Use simulation of the current model to find out suitable requirement for the next level
 - Use the old and add additional requirements

Design flow cont.

- Third model adds bit true effects, wordlengths etc. (structural)
 - Work with fixed point numbers
 - Add timing
 - Include overflow and truncation
- Fourth model are synthesizable (Altera blocks)
 - Detailed timing
 - Generate hardware

Tool details

- Documentation available online (on the machines)
- Windows-machines do not use the same version of the tools
 - If you use windows versions, check documentation first

Simulink Schematics

- Hierarchical schematics
- Combine blocks from libraries
- Create your own libraries
- Mask hides sublevels
- Parameter entry through masks

Simulink

- Simulates dynamic systems
- Built on top of Matlab
- All Matlab functions accessible
- Linear and non-linear systems
- Continuous time and/or discrete time

Simulink Programming

- S-functions describe blocks
 - Interface
 - Number of functions (start, step etc.)
 - State
- Programming languages supported
 - M-files (matlab script files)
 - C-MEX, C++, Ada, Fortran...
- Simulation model differs from VHDL

Simulink Typical blocks

- Blocks divided into libraries
 - Simulink
 - Communications Systems Toolbox
 - DSP Systems Toolbox
 - Simulink Extras
 - Altera Blockset

Telecom basics

- Assume knowledge about
 - Random variables
 - Discrete-Time signals
 - Discrete-Time systems
 - Linear Time-Invariant (LTI) systems
- If not, please look at the first chapter of the book (or literature in the corresponding courses)

Simulink Extensions

- Large set of toolboxes
 - Finance ... Math ... Control
- Real Time Workshop (RTW)
 - Schematic -> C-programs
 - Supports DSP and general CPU

Components of a digital communication system

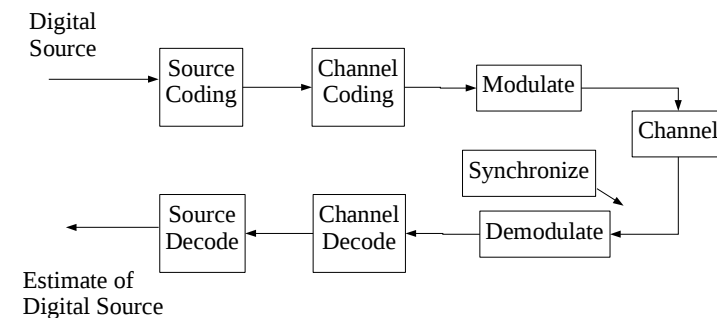

Building blocks

- Source coding
 - Reduce redundancy in the source data
 - Example: English language
 - No gain if input data is statistically independent (memoryless)

Building blocks, cont.

- Channel
 - Medium that stores/transfer the information
 - Wire, Radio, Optics, Magnetic media etc.
 - Usually distorts the sent information

Building blocks, cont.

- Channel coding
 - Will be covered in a later lecture (protects data from single bit errors)
- Modulation
 - Translate a symbol into an analog signal to send over the channel
 - Multiple bits may be transmitted in each symbol
 - Rate of symbols sent is called “Baud rate”
 - Note: Baud rate NOT EQUAL TO bits/s

Baseband modulation

- The modulated signal is sent directly in the channel
- Typical example: Modems, ADSL, VDSL etc.
- Signal contains information at low frequencies (possibly also DC)

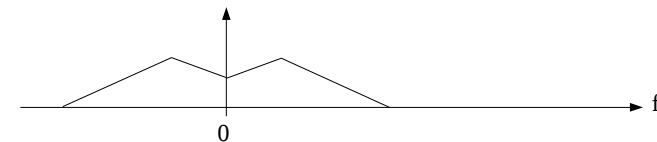

Band-pass modulation

- The information is embedded in a carrier frequency f_c .
- Information in carrier amplitude, phase, and/or frequency
- Assume sinusoidal carrier
- No information outside $f_c \pm BW/2$

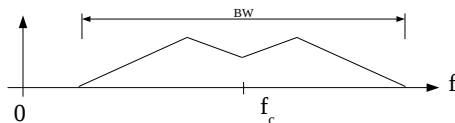

How to encode information onto an analog waveform

- Amplitude
 - Produce a carrier, change its amplitude
- Phase
 - Generate a carrier, delay it to change phase
- Frequency
 - Vary frequency of carrier
- Shape
 - Select shapes according to symbol to send
 - Non-sinusoid will lead to use of spectrum outside the carrier frequency (e.g., square wave)

Digital Communication

- Transmit symbols on to the channel
 - Use different waveforms for different symbols
 - Symbols have a symbol time equal to 1/symbol rate
- Waveform limitations
 - Amplitude limited
 - Length (time) limited
 - Bandwidth limited
 - Should be easy to generate and detect

Simple cases, sinusoidal carrier

- Amplitude modulation (AM)

$$y(t) = A(t) \sin(2\pi f_c t)$$
- Phase modulation (PM)

$$y(t) = \sin(2\pi f_c t + \text{Phase}(t))$$
- Detect value at receiver by comparing with reference
 - Require stable and well matched reference
 - Environment affects received amplitude (attenuation)
 - Environment affects received phase (delays)
- General: $y(t) = A(t)\sin(2\pi f_c t + \phi(t))$

Representing amplitude and phase: Constellations

33

- Transmitted symbols usually drawn as constellation
 - I (inphase) and Q (quadrature) axis describe cosine and sine terms of the carrier sine curve

$$A \sin(2\pi f_c t + \phi) = B \sin(2\pi f_c t) + C \cos(2\pi f_c t)$$

- Polar coordinates => amplitude and phase of the carrier signal

- Example $f(x,t) \Rightarrow f(0,t) = 1$
 $f(1,t) = -1$

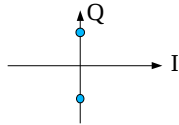

$$y(t) = f(x,t) \sin(2\pi f_c t)$$

Phase Shift Keying (PSK)

35

- Constant amplitude, only phase changes (in example starts at $\pi/4, 3\pi/4, 5\pi/4, 7\pi/4$)

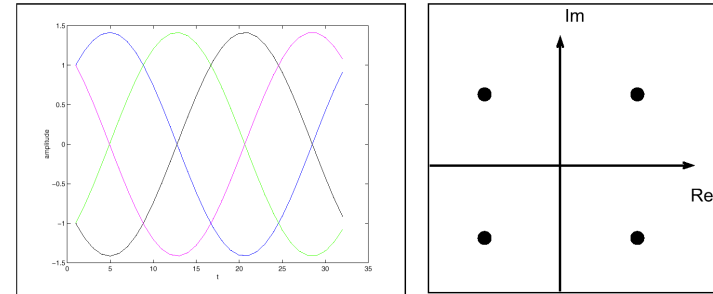

Binary Phase Shift Keying (BPSK)

34

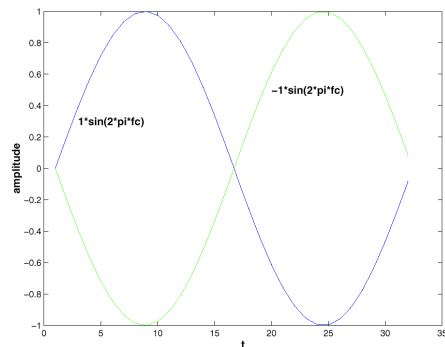

PSK cont.

36

- Transmitted signal

$$\cos(2\pi f_c t - \phi_x) = \cos(\phi_x) \cos(2\pi f_c t) + \sin(\phi_x) \sin(2\pi f_c t)$$

$$= f_I(x, t) \cos(2\pi f_c t) + f_Q(x, t) \sin(2\pi f_c t)$$
- Rewrite using complex representation

$$= f_I(x, t) \cos(2\pi f_c t) + j \cdot f_Q(x, t) \sin(2\pi f_c t) = f_{I,Q}(x, t) \cdot e^{j2\pi f_c t}$$
- $F_I(x,t)$ and $F_Q(x,t)$ is selected differently depending on modulation method

Quadrature Amplitude Modulation (QAM)

37

- Modulate both amplitude and phase
- Use equal distance between all points

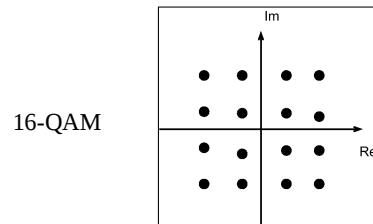

Channel Model

39

- Distorts the signal due to reflections and diffractions, effects are time-variant
- Multipath: The transmitted signals travels through many different paths before reaching the receiver
- Delay spread, attenuation, frequency broadening
- Simplest model treats the channel distortion as noise (Additive White Gaussian Noise, AWGN)

Creating the modulated carrier

38

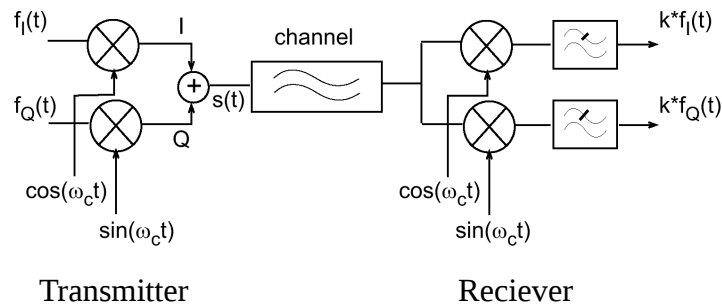

Channel Model, cont.

40

- Fading occurs when phase of the signals from two paths differs by approximately π
- Output from the channel (LTI channel model)

$$f_{rec}(x, t) = f(x, t) \otimes h(t) + n_{ch}(t) \text{ or in the Fourier domain}$$

$$F_{rec}(e^{j\Omega}) = F(e^{j\Omega}) \cdot H(e^{j\Omega}) + N_{ch}(e^{j\Omega})$$

where $h(t)$ is channel impulse response, and $n_{ch}(t)$ is the noise in the channel

- Output consists of rotated and scaled version of the input signal plus noise

Channel Model, cont.

- Common channel models are Rayleigh fading channel and Rice fading channels.
- Multipath spread (T_m) corresponds to time between first and last received signal version
- Coherence bandwidth $B_m = 1/T_m$
- If signal bandwidth $\ll B_m \Rightarrow$ flat fading channel
- Typical indoor channel has T_m less than 200 ns (usually less than 100 ns)

Wireless communication, cont.

- High data rate \Rightarrow Large bandwidth (BW)
- $BW \gg$ Coherence bandwidth \Rightarrow frequency selective fading
 - Coherence bandwidth = $1/T_m$ (multipath spread)
- Possible solutions
 - Use multiple narrow carriers
 - Use equalizer to even out effect (inverse of impulse response)

Channel Model, cont.

- Channel characteristics are time-varying
- Coherence time: Duration over which the channel characteristics do not change significantly
- If coherence time $>$ time to send a number of symbol, then the channel is a slow fading channel
- Indoor channels are frequency-selective slowly fading channels

Multi-carrier Multiplexing

- Reduce effects of frequency selective fading by use of multiple carriers
- Each carrier must be non-overlapping with the other carriers to enable detection of data
- Leads to inefficient use of bandwidth